



Omlet Limited  
Unit 4 Tuthill Park  
Wardington  
Oxon OX17 1RY

[www.omlet.co.uk](http://www.omlet.co.uk)  
[info@omlet.co.uk](mailto:info@omlet.co.uk)  
0845 450 20 56

# Eglu Go

## Instruction Manual



**PLEASE READ CAREFULLY**

**What you have received:**



If your Eglu Go arrived by courier, please remember to retain all the packaging it arrived in. In case you wish to return the Eglu Go or any part of the Eglu Go, it must be sent back in the original packaging and have no more than normal wear and tear to receive the full product refund.



The Eglu Go house box



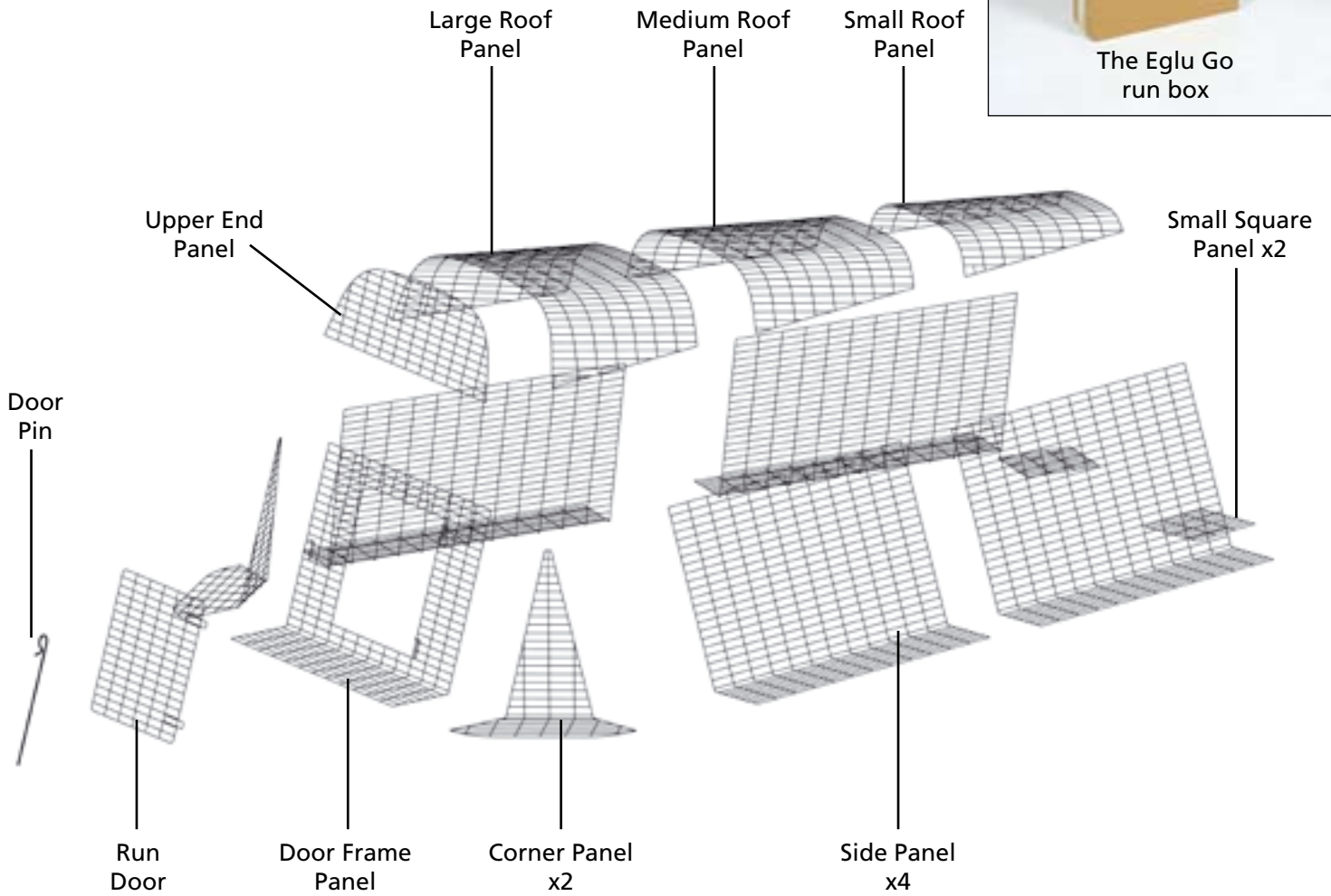

Double Run Clips x6



Run Clips x70 approx



Shade



Bungee Hooks x4

### Run pack



Double run clip x6



Run clip x70

### Fastener pack

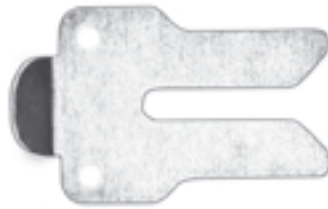

Run bracket x4



Strut x2



Small screw x10



20mm bolt x6



Strut bolt x4



Shoulder bolt x4



20mm washer bolt x4

### Other things you will need

Construction time. Approx 90mins.  
PLEASE read this instruction manual carefully.

30 mins + 60 mins

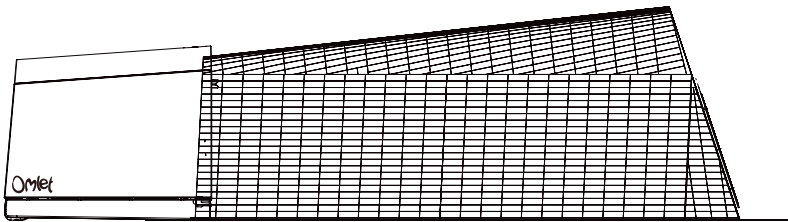

**CAUTION:**  
Please only use hand tools whilst constructing your Eglu GO. Electric screw drivers and drills can damage the product.



A cross-head screwdriver  
(Size PZ2)

## Assembling Your Go

### BEFORE ASSEMBLING - Find a suitable surface and location in your garden

You should assemble the Eglu Go on a spot that is reasonably even and flat. Make sure you leave enough space behind the Eglu Go to allow the dropping tray to be removed and enough room in front to open the run door.

The diagram shows the Eglu Go dimensions.

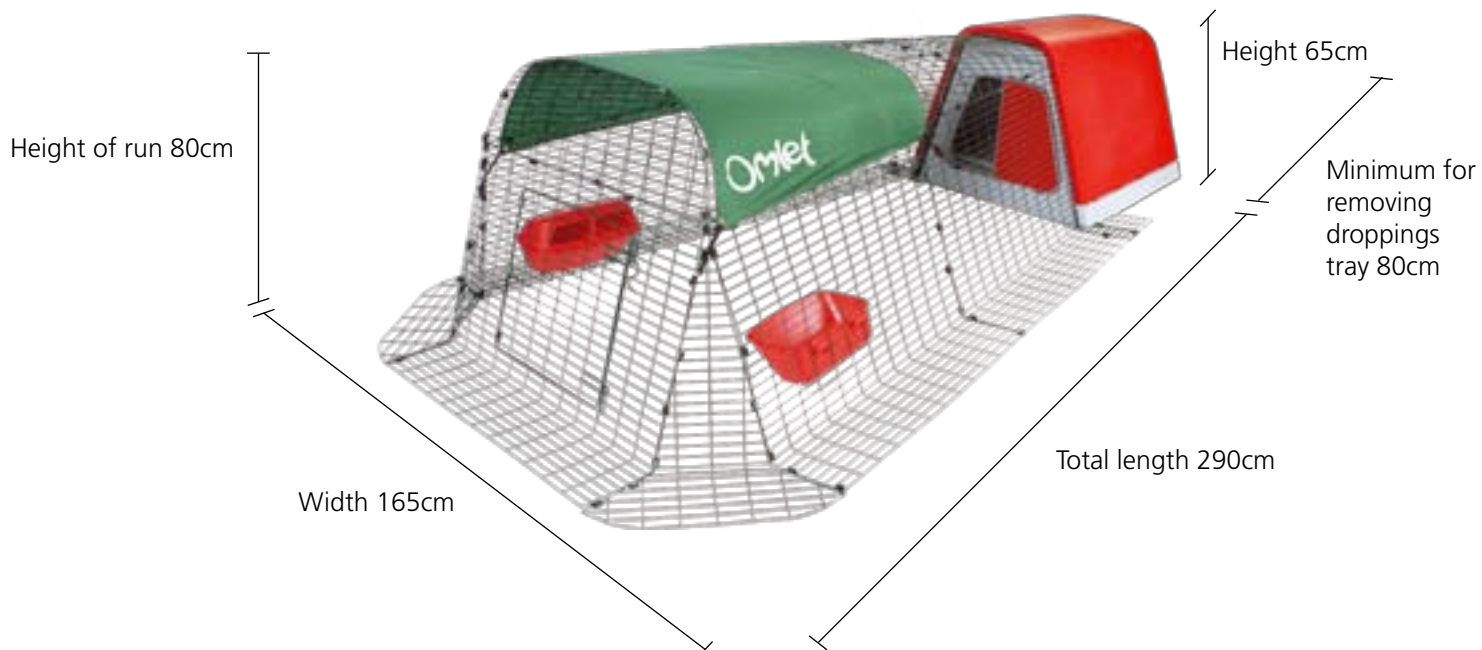



## Step 1 - Attach the Left Inner Side Panel to the Front Fascia

You will need:



X2  
20mm washer bolts

Line up the holes in the side panel with the holes on the front face. Once together screw in place with 2 20mm washer bolts.

REPEAT ON OTHER SIDE

**NOTE:** The front fascia should be laid FACE DOWN with the front door facing down.



## Step 2 - Attach Skid Bar



X4  
small screws

Line the skid bar up with the side panels as shown. Please note the orientation. Fasten together using 2 small screws.

Repeat on the other end of the skid bar.



**BE CAUTIOUS. DO NOT OVER TIGHTEN SCREWS.**

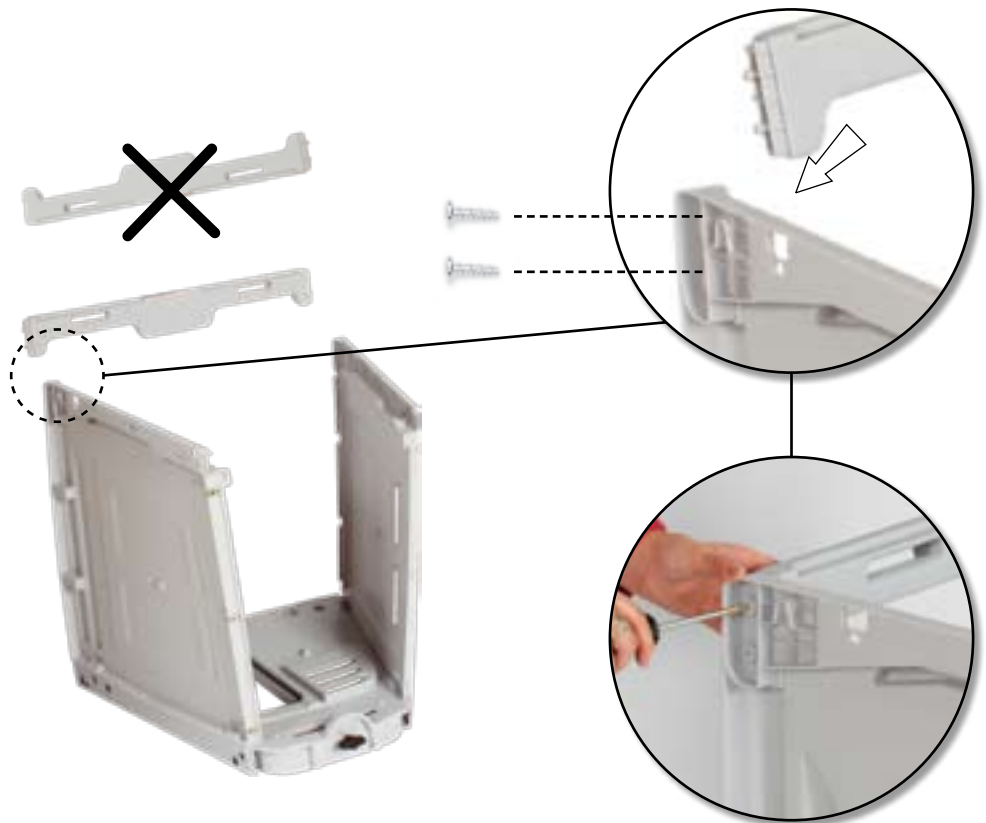

### Step 3 - Attach the Roof

X6  
20mm bolts

Now turn the product upright.

Position the lid inner as shown and fasten with 6 20mm bolts.



### Step 4 - Attach the Support Struts

X4  
strut bolts



X2  
struts

Place the **struts** inside the **Eglu Go** in the upper corners as shown. Line up the **struts** with the holes in the orientation shown and **loosely** screw in place.

REPEAT ON OTHER SIDE

Now tighten all 4 bolts.



IF YOU DO NOT HAVE A RUN TO ATTACH, SKIP TO STEP 15

## Step 5 - Attach the Run Panels to the Eglu GO

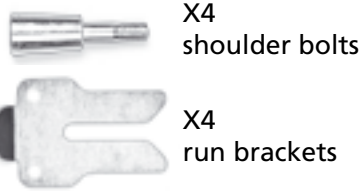

Before attaching the run decide where you want the **door panel** to be. It can be in 5 different locations - the end, or two positions on each side. In this manual, the door will be at the end of the run.

Slide a **run panel** into the narrow gap between the **front face** and **side panel**.

Make sure the panel hooks over the two **location wedges** near the bottom of the **front face**, and is pressed against the **stops** at the top, as shown.

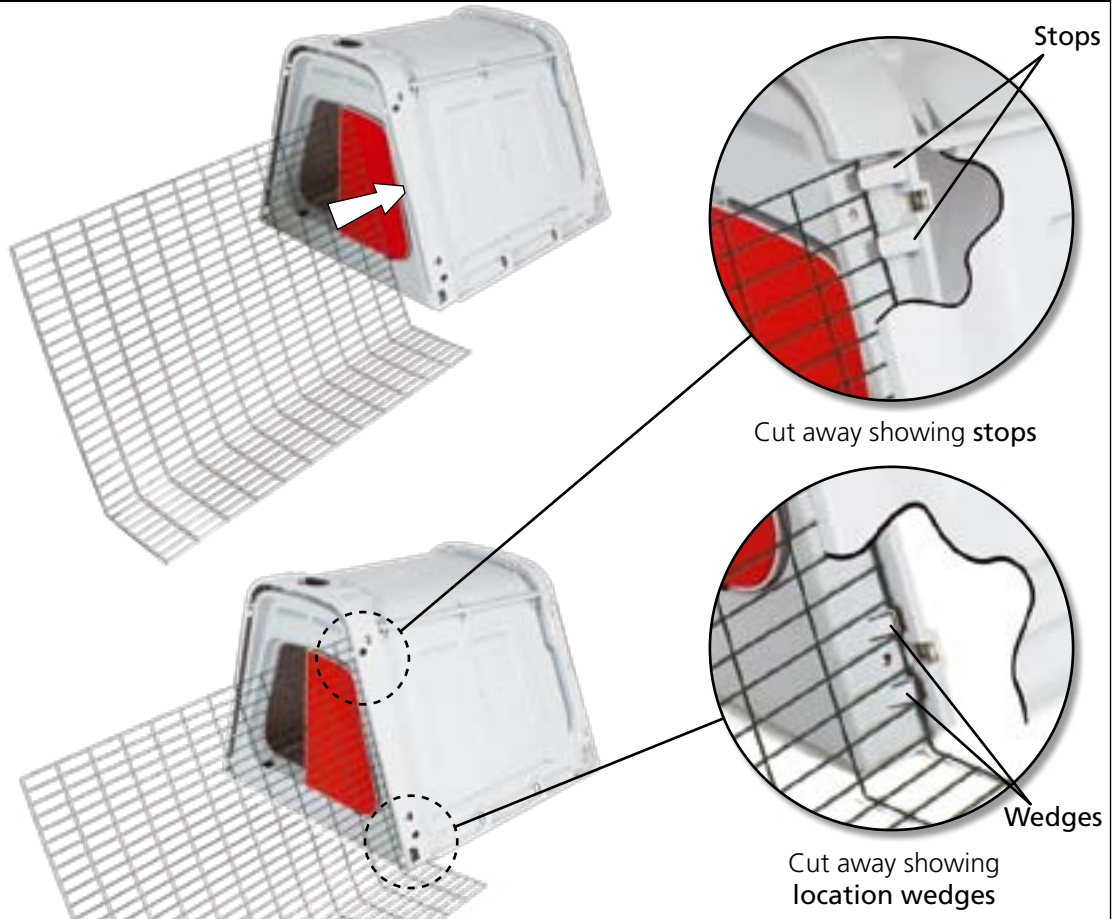

## Step 6 - Attach the Shoulder Bolts

Insert a **shoulder bolt** into the lower hole as shown and turn once.

Slide a **run bracket** in from the front of the eglu as far as possible making sure its 'legs' are around the **shoulder bolt**.

Holding the bracket in place, tighten the **shoulder bolt** up.

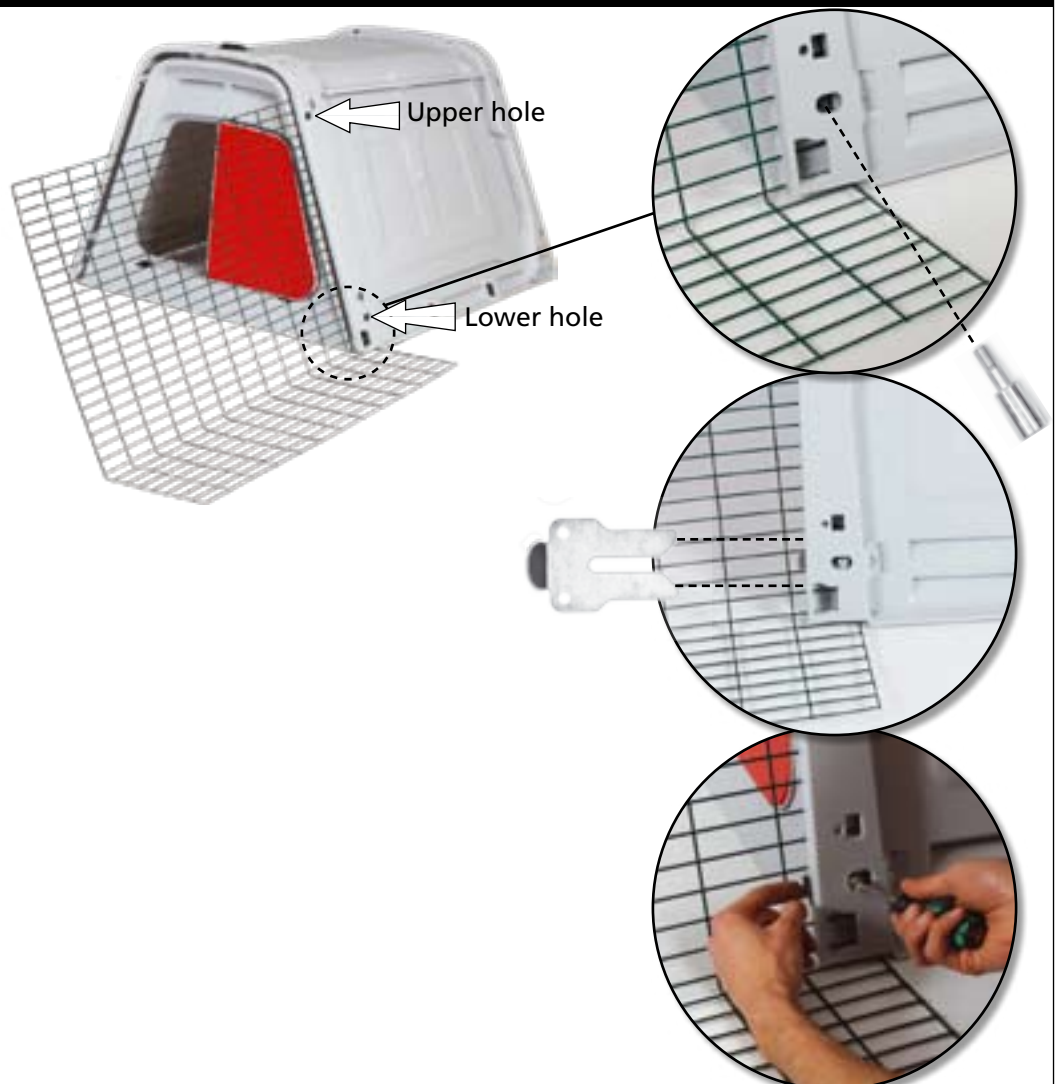

REPEAT FOR UPPER HOLE

REPEAT ON OTHER SIDE



## How to use the Run Clips



Take a **run clip** between thumb and fore finger as shown and squeeze.



Position around the two wires to be joined.



Squeeze the clip and it will click shut.



To undo a **run clip**, twist a coin between the legs as shown.

## How to use the Double Run Clips



Bend the **double run clip** open as shown above. Whitening of the plastic will occur but will not weaken the clip.



Position around the wires to be joined.



Squeeze both clips to secure it in place.



To undo twist a coin between the legs as with the single run clip.

## Top Tip



**Having trouble using the run clips? Try my top tip.**

If you are assembling your **run clips** in very cold weather, you may want to warm them up by placing them in a bowl of warm (not boiling) water for 10 minutes. This will make them softer and easier to clip together.



## Step 7 - Attaching the Small Roof Panel using your Run Clips



Use the diagram on **page 3** to make sure you use the correct **run panels** and the diagram on **page 13** to ensure you put the **run clips** in the correct location.

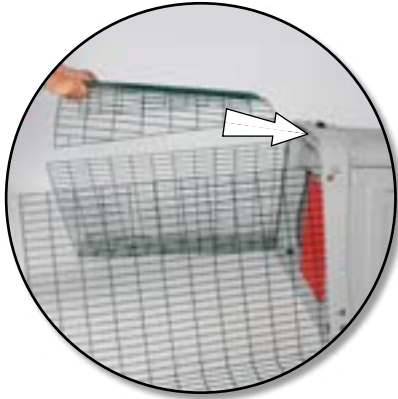

Slide **small roof panel** into the gap in the front face. Make sure the panel is pushed up against the stops on the front face.



**IMPORTANT**  
It is essential that you attach a **run clip** in this position.

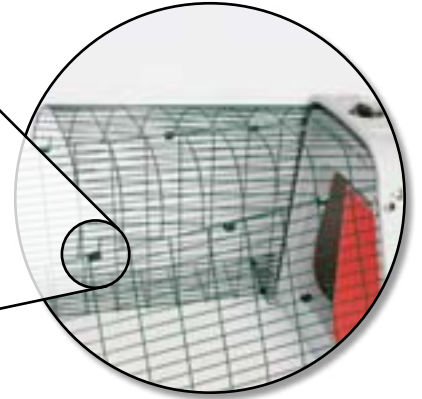

Clip the panel to the side panels as shown. The circle highlights the critical **run clip** position. Use **3 run clips** on both sides.

## Step 8 - Attaching the Small Square Panels



Slide a **small square panel** under the house and side panel.



Clip the **small squares** on as shown using **3 run clips**.

## Step 9 - Attaching more Side Panels

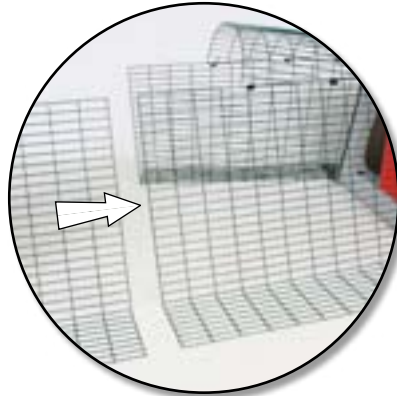

Offer up a side panel

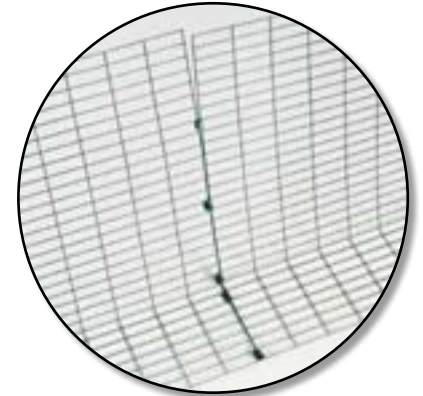

Clip together using 3 run clips on the side and 2 on the skirt in the positions shown. Repeat on the other side.

## Step 10 - Attaching the Medium Roof Panel

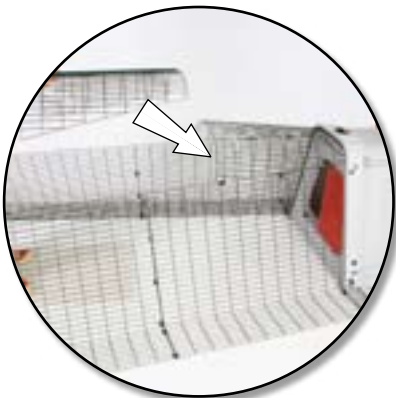

Attach medium roof panel. You will need to use double run clips at this stage. Use 1 run clip either end plus a double run clip in the position shown.

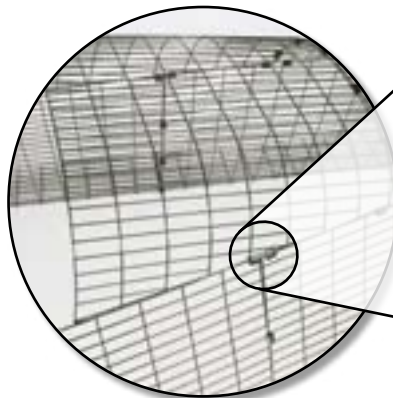

Key positions of double run clip illustrated above, (repeated on other side.) Use 5 run clips to join to the small roof panel.

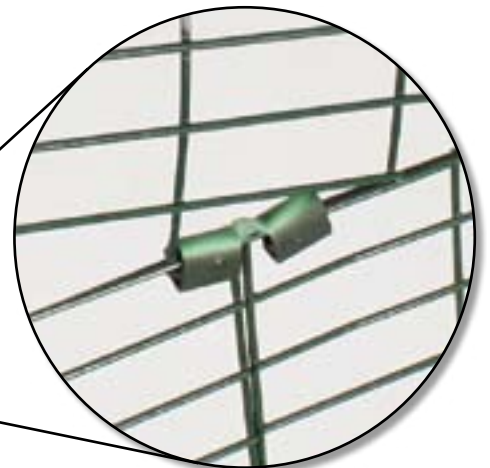

**IMPORTANT**  
Put a double run clip in this position.

## Step 11 - Attaching the Large Roof Panel

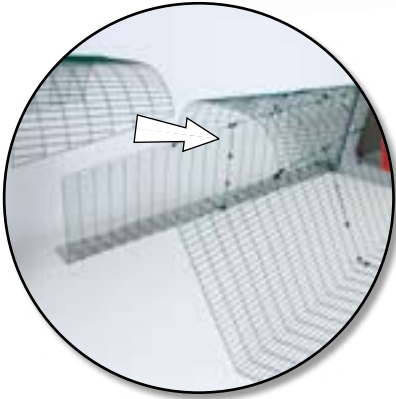

Attach large roof panel.  
Use 5 run clips to join to the  
medium roof panel.

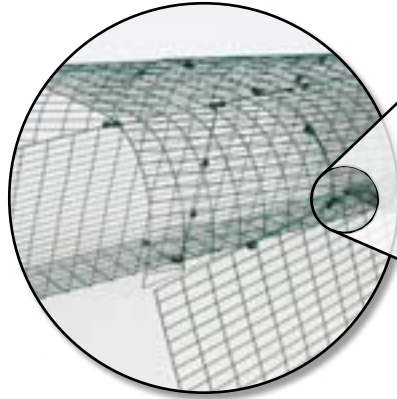

And 2 run clips  
on either side in the  
positions shown.

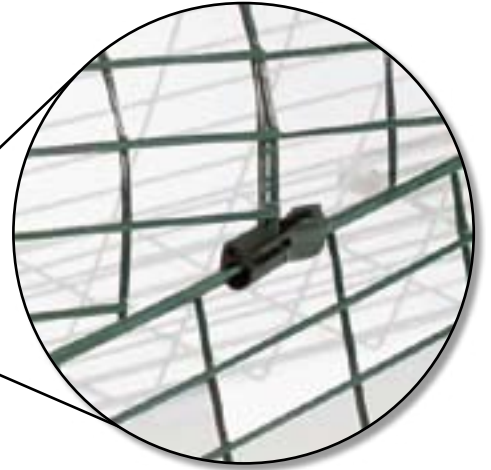

**IMPORTANT**  
Put a **double run clip**  
in this position.

## Step 12 - Attaching the Corner Panels

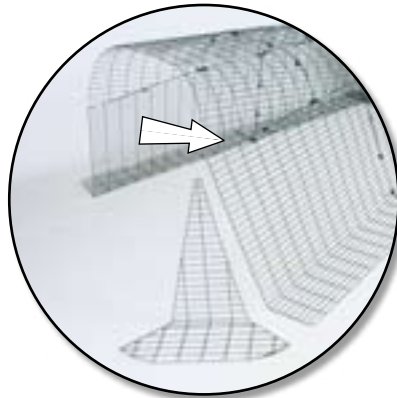
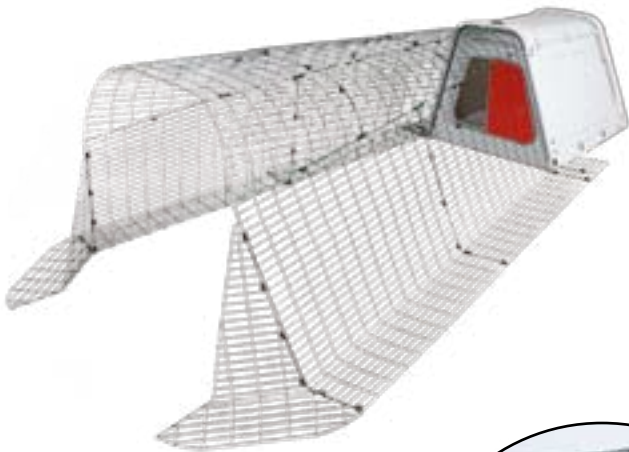

Attach corner panel. Use 2 run clips on the skirt  
and 3 run clips up the side.

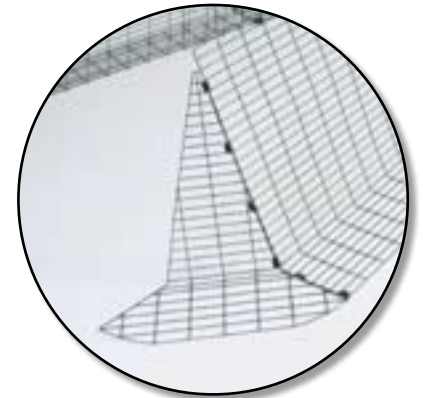



### Step 13 - Attaching the Door Frame Panel

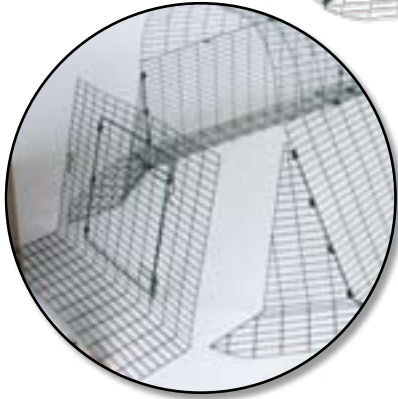
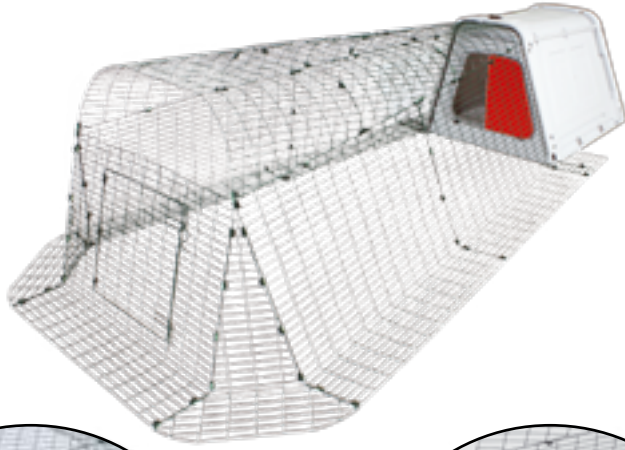

Attach door frame panel  
Clip from the bottom upwards.

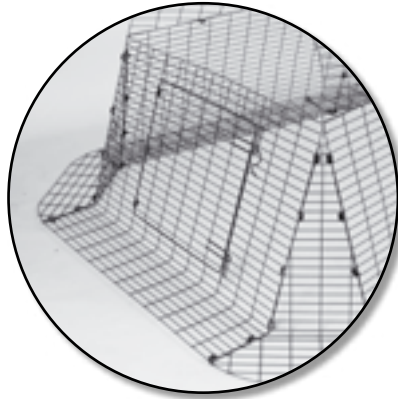

Use 2 run clips on the skirt and  
4 run clips up the side.

**IMPORTANT**  
Don't use a run clip at the very top of  
the left and right corners of the  
door panel yet.

### Step 14 - Attaching the Upper End Panel



Attach upper end panel. Use 4  
run clips along the bottom edge.  
And 7 run clips across the top.

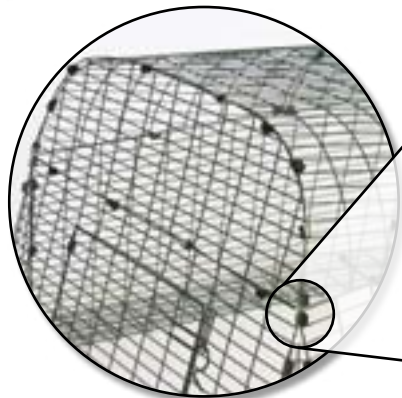

Add a double run clip on  
the top corner as shown

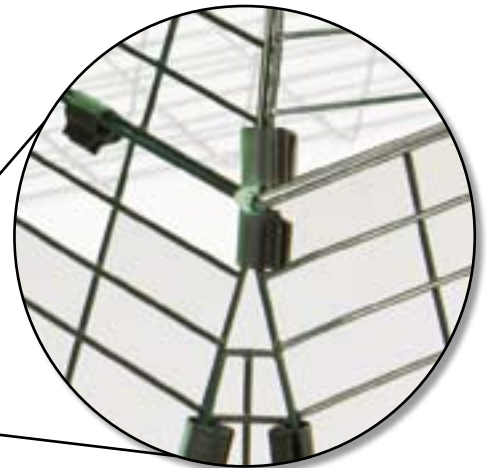

REPEAT ON OTHER SIDE

Here is a diagram showing all run clip positions.

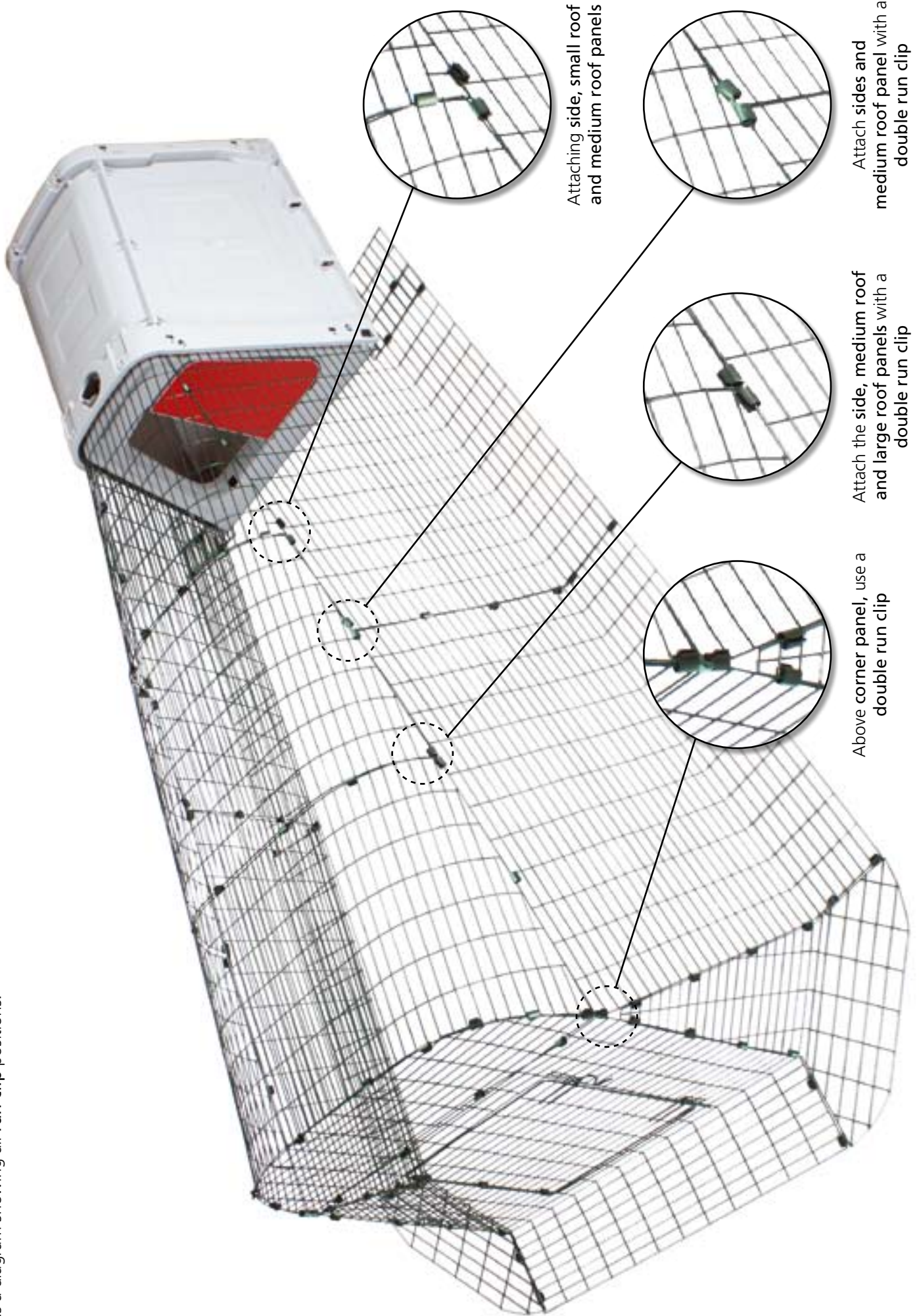



## Step 15 - Attach the Side Bumpers



X2  
small screws

Line up the hooks in the side bumpers with the holes on the side panel shown in the diagram. Then slide it towards the back of the Eglu Go until it is level with the back.

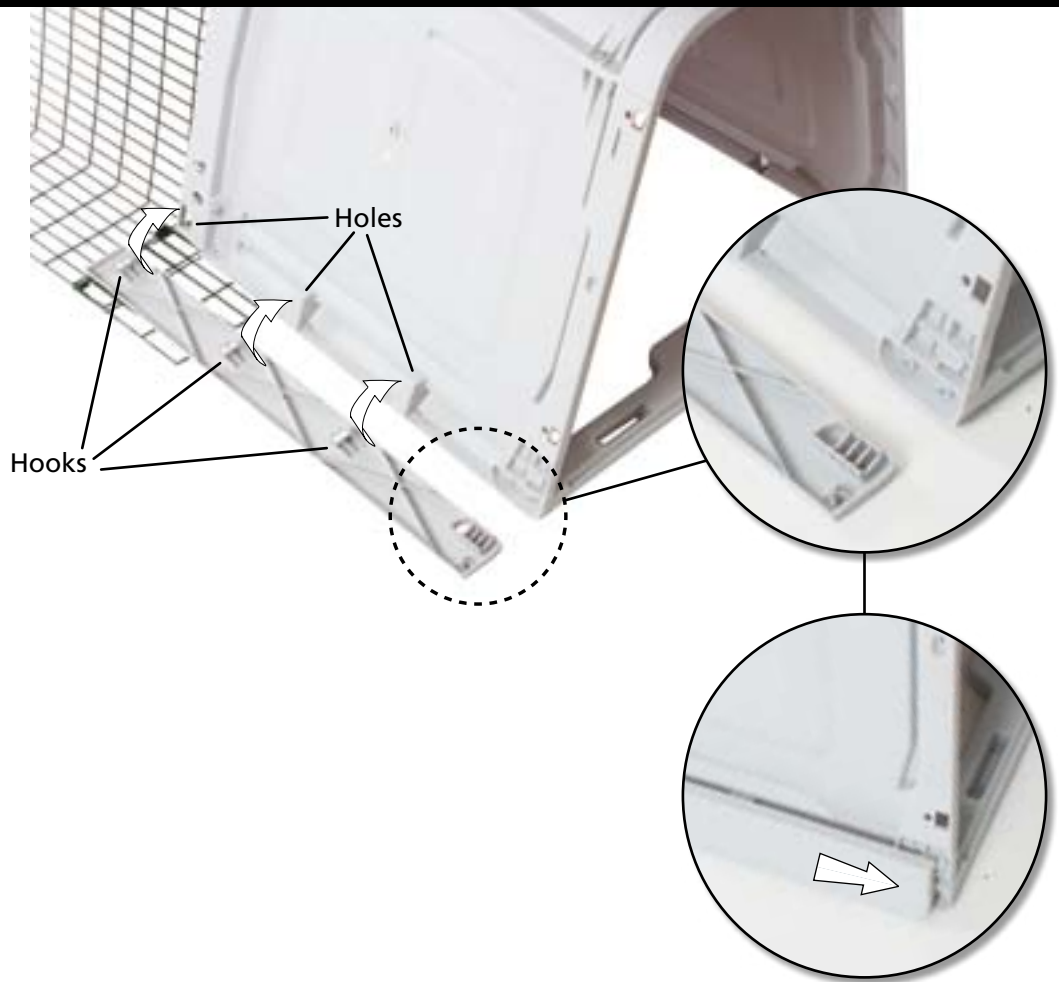

## Step 16 - Attaching the Side Bumper

Now secure the side bumper from inside the Eglu Go using a small screw.

REPEAT ON OTHER SIDE



BE CAUTIOUS. DO NOT  
OVER TIGHTEN SCREWS.

Screw  
hole

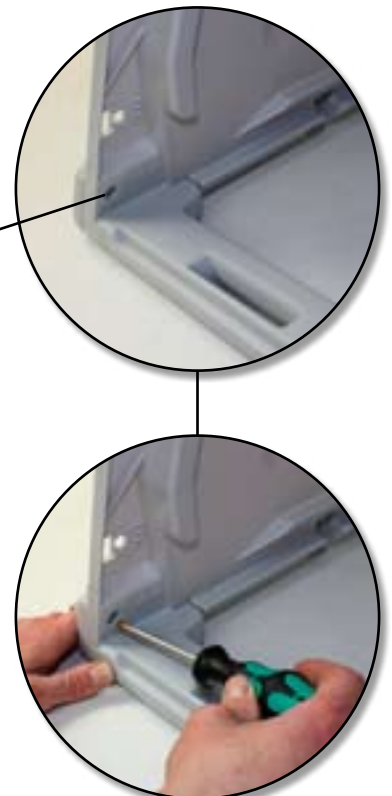



### Step 17 - Attach the Side Outer Panels

Hook a side outer panel onto the bumper as shown.

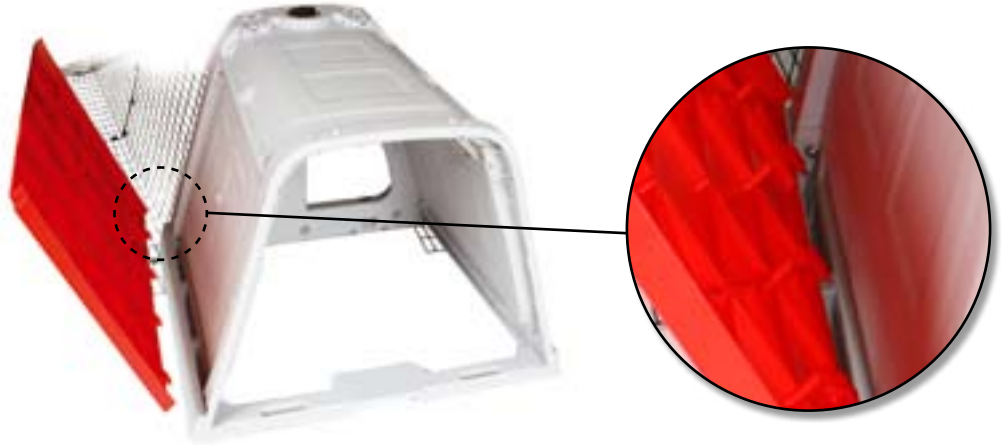

REPEAT ON OTHER SIDE

### Step 18 - Secure Side Outer Panels

X2  
small screws

Screw side outer panel to side inner panel using 2 small screws as shown. You will notice a small gap under the side outer panels, these are air gaps for ventilation.



REPEAT ON OTHER SIDE

### Step 19 - Attaching the Lid

Line the lid up with the Eglu Go and press firmly into position. 4 snap fits will hold it in place.

**NOTE:** To remove the lid see "How to use your Eglu Go" at the back of the instructions.

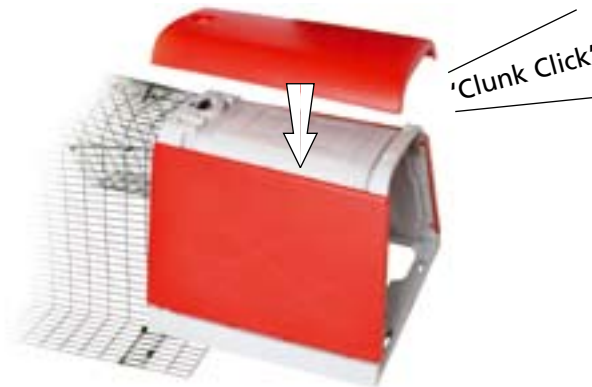

### Step 20 - Slide in the Roosting Rack and Droppings Tray

Slide the roosting rack and droppings tray into place.



Slide in

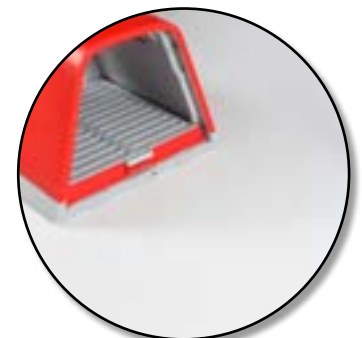

Droppings tray and roost rack in place.

### Step 21 - Attach the Rear Panel

Hook the **rear panel** into place as shown. Push the **panel shut** and rotate the **handle** clockwise to lock it.

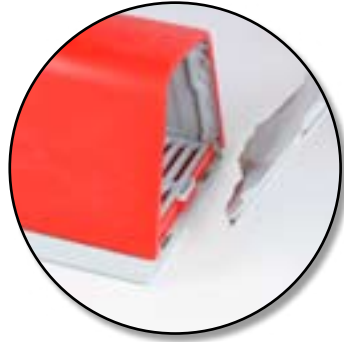

Hook in place



Push shut



Turn clockwise to lock

### Step 22 - Put Feeder together

Assemble the **feeder** before adding it to the run.



Line up the **grub base** with the **grub lid**



Clip together using the eyelets around the edge



Push firmly in place.

### Step 23 - Attach the Shade, Feeder and Drinker

Attach the **shade** in place as shown using the four bungee hooks.

'Grub' feeder and 'Glug' drinker hook onto the run as shown.



Place the **drinker** as low down as possible to allow the chickens to drink from it.

**VERY IMPORTANT.**  
**PLACE DRINKER JUST OFF GROUND LEVEL.**

The **feeder** should be hung at chicken 'head height'.

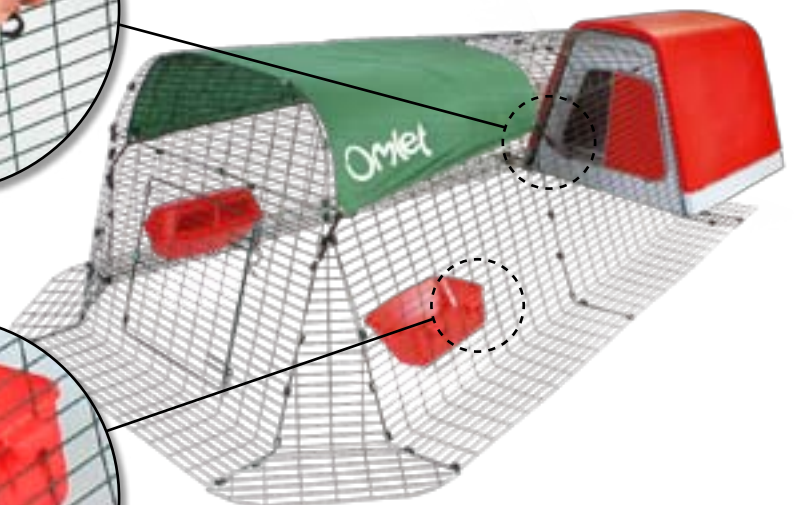
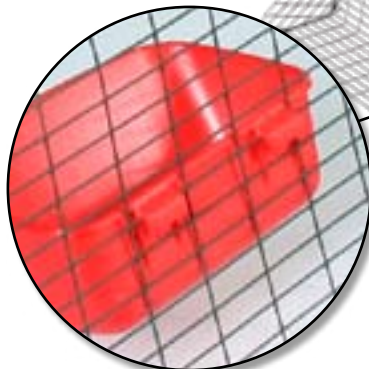

**THAT'S IT! CONGRATULATIONS YOUR BRAND NEW EGLU GO IS NOW READY FOR CHICKENS.**

# Using your Eglu Go

## Front Door



Pull the handle at the top of the house until it stops.



Turn the handle to close the door.



Lock the door by pushing the handle back down.

## End Panel



Undo the end panel by turning the handle clockwise.



Pull the panel back and lift up to remove.



Replace the rear panel.



Secure the door by turning the handle anti-clockwise.

## Droppings Tray and Roosting Rack



With the end panel removed you can slide the droppings tray in and out.



You can slide the roosting rack out by pulling on the grey handle.



## Removing the Lid and Outer Panels

If you want to move your **Eglu Go** to a new garden then you will need to take the run apart. Remove the **outer lid** by un-clipping the **snap fits**. There are two found just inside the roof of your **Eglu Go**. Gently release them with your thumbs and ease the **lid** off. You will also need to remove the side panels, remember to undo the screws inside, see far left image. Now undo the **four bolts** that hold the run to the **Eglu Go**. If you lose any clips along the way you can get more by going to [www.omlet.co.uk/shop](http://www.omlet.co.uk/shop) or by calling 0845 450 2056.





## Move your Eglu Go

If you want to move your **Eglu Go** to a new location in your garden hold on to the run at the furthest end from the **Eglu Go**. Lift and slowly drag to a new patch of grass.

Ask a friend to help you if you need assistance.



Bend your knees and lift just above the run skirt.



Drag to its new location.

## Eglu Go Do's and Don'ts

**Do** collect and enjoy your eggs everyday. Leaving eggs in the Eglu Go can cause your chicken to go broody and not lay any eggs for a few weeks.

**Do** make sure your chickens have food and water. Without food and water your chickens will die.

**Do** let your chickens out of the eglu everyday. If you are away, then leave the Eglu Go door open so that the chickens can get out into the run in the morning. Not letting your chickens out will lead to distressed chickens and could lead to terminal overheating.

**Do** supervise children when they are using the Eglu Go or interacting with the chickens. Chickens can be unpredictable and peck at anything including people.

**Do** take extra care when using the lawn mower around the 'skirt' of the run. Without care you will damage the 'skirt' with the lawn mower.

**Do** wash your hands after coming in contact with the Eglu Go or chickens.

**Do** be aware that chickens have sharp beaks and claws and they may peck or scratch at something that resembles food or looks interesting to them. Small shiny things are especially attractive to chickens.

**Do** check that the run door and rear panel are well fastened. If they are not secure your chickens are at a greater risk of a predator getting them.

**Don't** sit or climb on the run. This is not only dangerous but can lead to the run being damaged.

**Don't** let children inside the run or Eglu Go. This could lead to them getting stuck.

**Don't** leave the door of the run open while your chickens roost at night. This will compromise your chickens safety by allowing predators to get into the run.

**Don't** keep the Eglu Go on uneven ground as this will make the run less secure. It can also cause the run 'skirt' to be a tripping hazard.

**Don't** use bleach, solvents or strong detergent to clean the Eglu Go, they could damage the plastic.

**Don't** keep the Eglu Go near sources of ignition, such as a bonfire or barbecue, because they could set the Eglu Go on fire.

**Don't** use the Eglu Go for anything other than housing chickens. It has not been designed for any other purpose.

**Don't** keep more than 2 heavy breeds, 3 medium sized breeds (like the Gingernut Ranger and Miss Peppercorn) or six bantams in an Eglu Go. This will cause overcrowding and distressed birds.

For further information go to [www.omlet.co.uk](http://www.omlet.co.uk)  
or you can email enquiries to [info@omlet.co.uk](mailto:info@omlet.co.uk)  
or call us on **0845 450 20 56**



**A Wide Range Of Accessories And Gifts**

In the Omlet shop you can find everything you need to keep your Eglu Go and chickens in tip top condition. You can order more chicken food, browse for books on chickens and find unusual items such as egg timers and mini frying pans that make perfect gifts for hen-enthusiasts. We also stock accessories for Eglus and (probably) the worlds largest selection of egg cups!



**Mixed Chicken Grit 1.25kg**

Not just any old grit either, a hard sharp flint is best of about 3-5mm diameter. This packet would last two hens a couple of months, just add a handful to the feed once a week.



£xx.xx

**Plaques**

Why should dog owners have all the fun? Stand out from the crowd with these notices and watch as unwanted visitors head for the hills. Suitable for outdoor use. Size 14 x 10cm approx.



£xx.xx

**Food Ball**

Keep your pets busy by hanging up some vegetables for them to nibble on. 8cm (3in) diameter steel wire ball.



£xx.xx

**Omlet Badges**

The range of fun badges is growing and growing. You will be able to prove to everyone that you are part of this eggsclusive club and are proud of it!



£xx.xx

**Car Stickers**

Show the world just how much you love chickens with these cool stickers. Stick them in your car, go for a drive and wherever you go people will know that you think keeping chickens is great.



£xx.xx

**Lip Balm Chicken Poop**

Whoever thought slathering your lips with chicken poop would make them so kissably soft and sweet smelling? This is a treat to put on and a pleasure to lick off. So pucker up and get pecking!



★★★★★  
**Lip Balm Chicken Poop**  
Good texture, scent and not claggy when applied. Definitely the best lip balm I have ever used, and that's saying something!  
GORGEOUS! By Mel

A great fun gift.

£xx.xx

If you would like to order these items please call **0845 450 2056** or you can order and pay securely online at [www.omlet.co.uk](http://www.omlet.co.uk)

**Link-a-board)**

The neat and easy way to edge your eglu's wood chipping area. This handy pack will enable you to construct an area measuring 3.5m by 2m. The 15cm tall plastic boards quickly slot together and form a durable edging.



Clips together in 3 easy steps.

**Includes:**

- 10 x 1 metre boards
- 2 x 1½ metre boards
- 4 x corner links
- 8 x straight links
- Fixings

£xx.xx

**Link-a-board Extension Kit**

This handy pack will enable you to extend your wood chip area by 1m. The 15cm tall plastic boards quickly slot to the original link-a-board to form a durable edging.

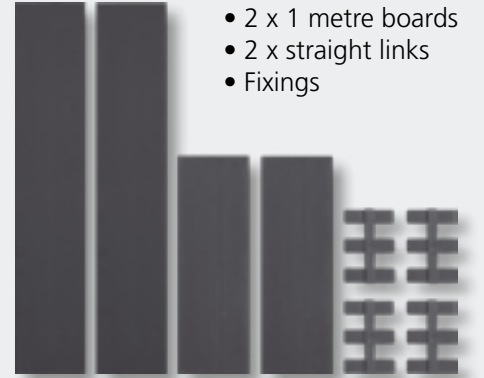

**Includes:**

- 2 x 1 metre boards
- 2 x straight links
- Fixings

£xx.xx

**Organic Omlet Feed & Corn**

Omlet's complete organic feed provides your hens with everything they need to stay in tip top condition. Why not top it up with some organic mixed corn as a treat to make them happy and turn yolks a lovely deep yellow. 10Kg Bags



£xx.xx

**Eglu Go Grub & Glug**

The purpose designed Eglu Go feeder and drinker or Grub & Glug to its friends is the best way to provide food for your chickens. It attaches to the run (both mark 1 and current eglu), keeps food dry and can be cleaned in a dishwasher. Will keep three chickens fed for two days.



£xx.xx

**Run Pegs - Pack of 12**

Ensure the Eglu run is firmly secured with these excellent pegs. Much better than ordinary tent pegs they screw into the ground making it extremely difficult for anything (eg a fox with a crowbar) to lift the run. Supplied with a tool for screwing them in.



Secure your run to the ground.

£xx.xx

If you would like to order these items please call **0845 450 2056** or you can order and pay securely online at **www.omlet.co.uk**



Omlet Ltd, Tuthill Park, Waddington, Banbury, OX17 1RR.  
Reg#5028498 VAT#837106436

Omlet®, Eglu®, No foxes allowed™ and Hen Parties™ are trademarks of Hebe Studio Ltd.  
Prices are correct at time of print including VAT at 17.5% but may be subject to change.  
Please call or look online for current prices.