

Omlet® zippi tunnel connector push button replacement

- DE Druckknopfersatz für Tunnelanschlüsse
- FR Remplacement du bouton poussoir sur le connecteur de tunnel
- NL Vervanging drukknop voor tunnelverbinding
- IT Pulsante di ricambio per il connettore del tunnel
- SE Utbyte av tryckknapp på tunnelanslutning
- DK Udskiftning af trykknop på tunnel forbindelsesled
- NO Utbytte av trykknapp på tunell-kobling
- PL Wymiana przycisków w zamku do klamry do tunelu

Old Push Buttons

DE Alter Druckknopf · FR Anciens boutons poussoirs
NL Oude drukknop · IT Vecchio pulsante
SE Gamla tryckknappar · DK Gamle trykknapper
NO Gamle trykknapper · PL Stare przyciski

063.1009

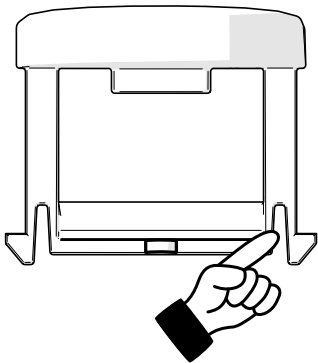

063.1013

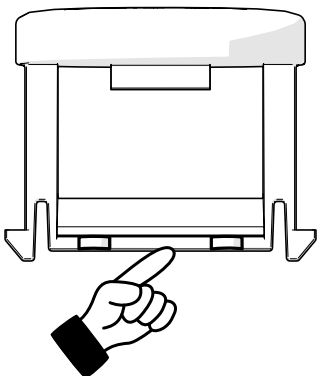

New Push Buttons

DE Neuer Druckknopf · FR Nouveaux boutons poussoirs
NL Nieuwe drukknop · IT Nuovo pulsante
SE Nya tryckknappar · DK Nye trykknapper
NO Nye trykknapper · PL Nowe przyciski

063.1009

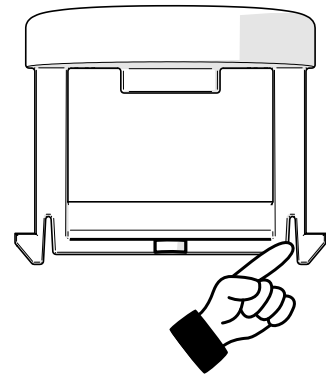

063.1013

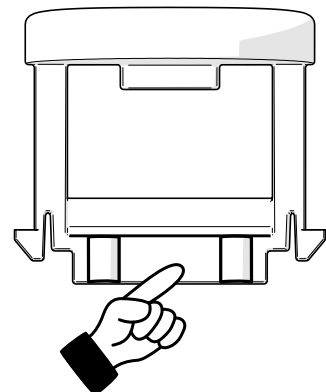

You will also need...

DE Das werden Sie benötigen · FR Ce dont vous aurez besoin · NL Ook heeft u nodig... · IT Avete anche bisogno di... · SE Du behöver också...
DK Du skal også bruge... · NO Du trenger også ... · PL Będziesz też potrzebować

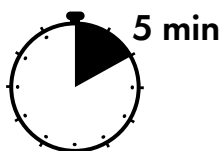

1

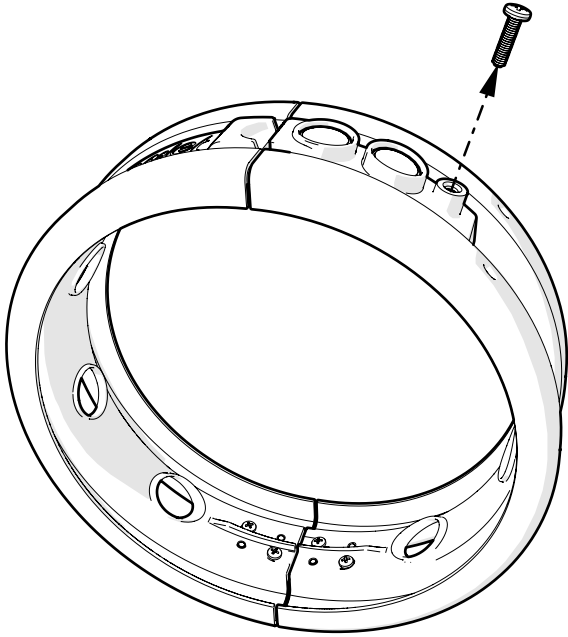

2

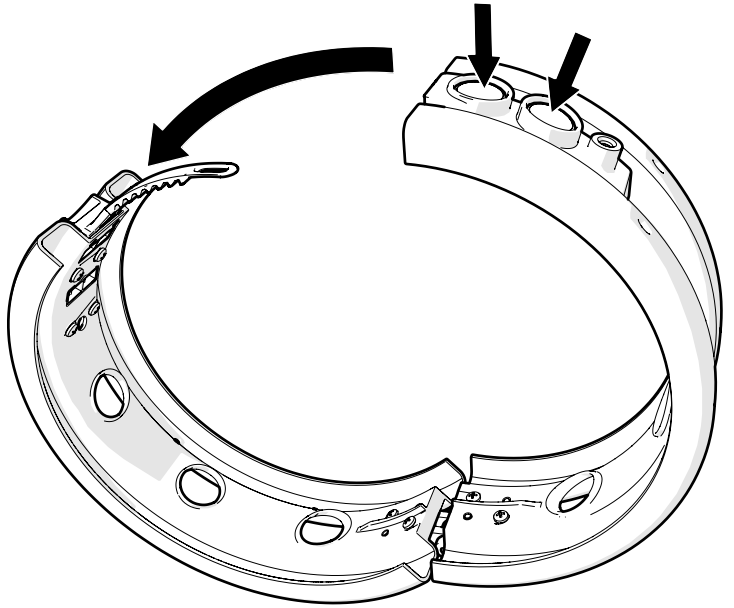

3

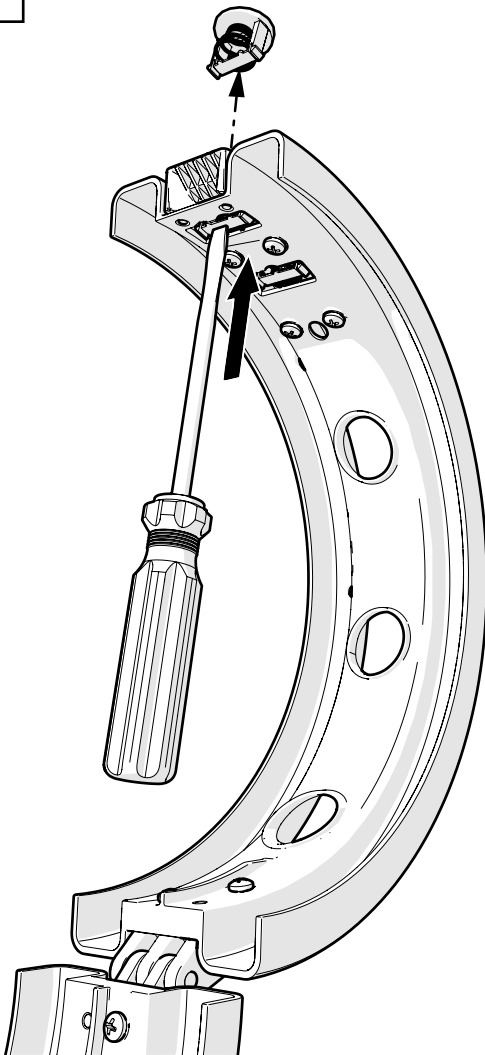

4

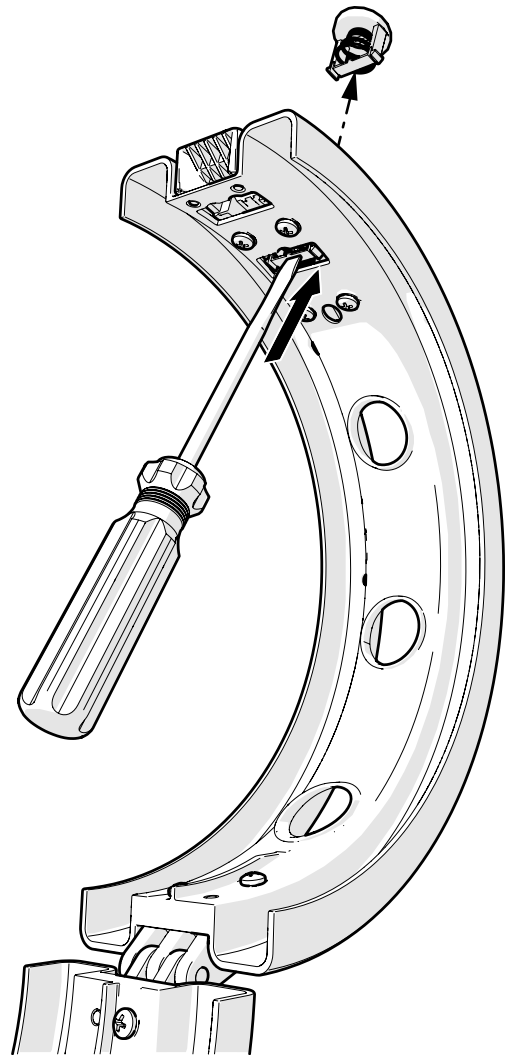

5

063.1009

063.1013

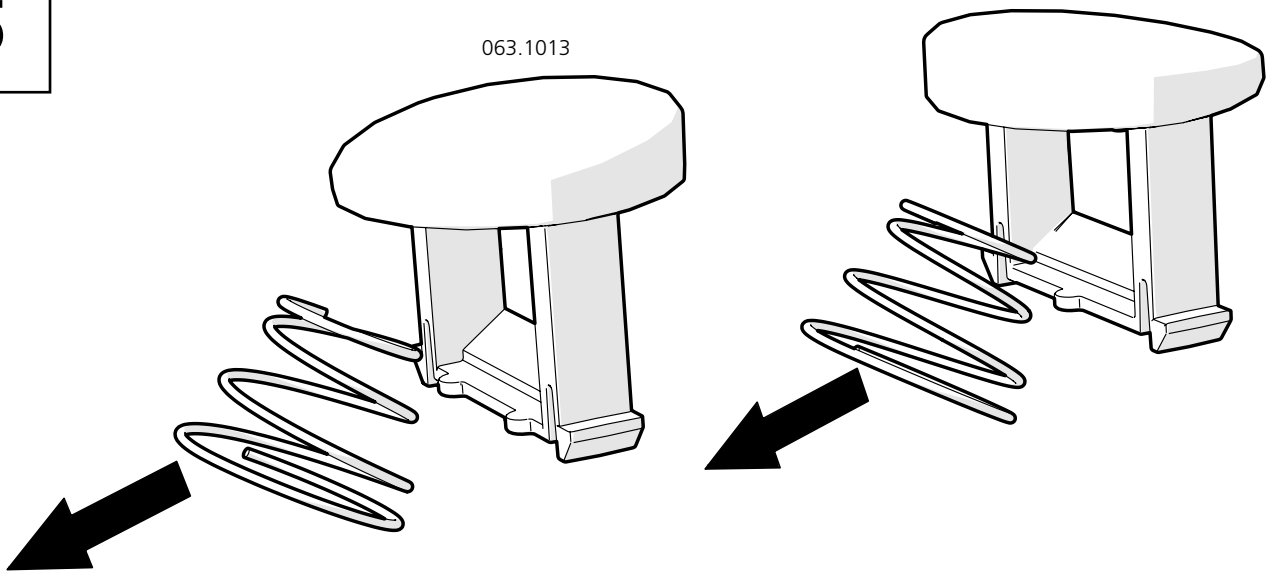

6

New Push Buttons

DE Neuer Druckknopf · FR Nouveaux boutons poussoirs · NL Nieuwe drukknop · IT Nuovo pulsante · SE Nya tryckknappar
 DK Nye trykknapper · NO Nye trykknapper · PL Nowe przyciski

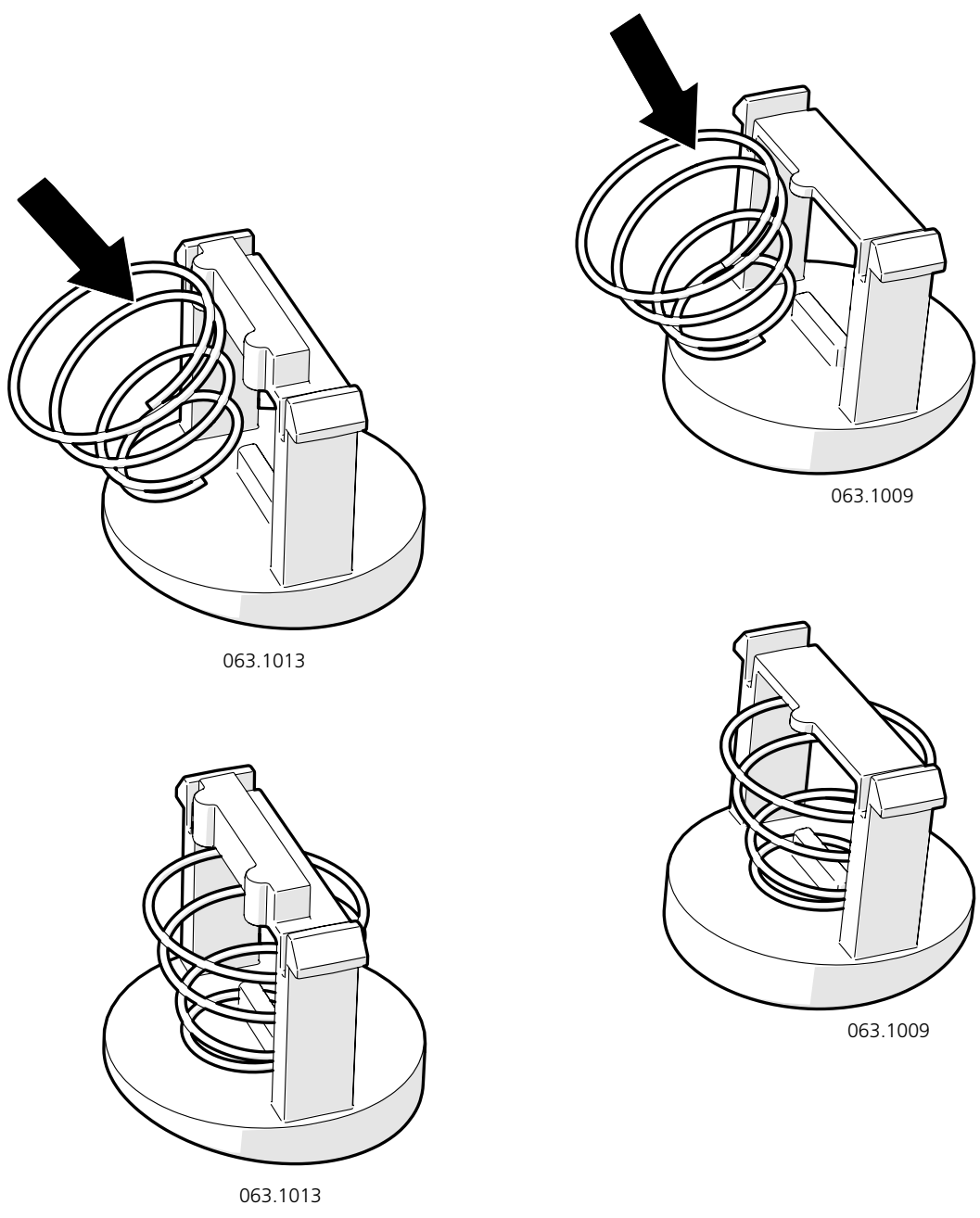

7

063.1009

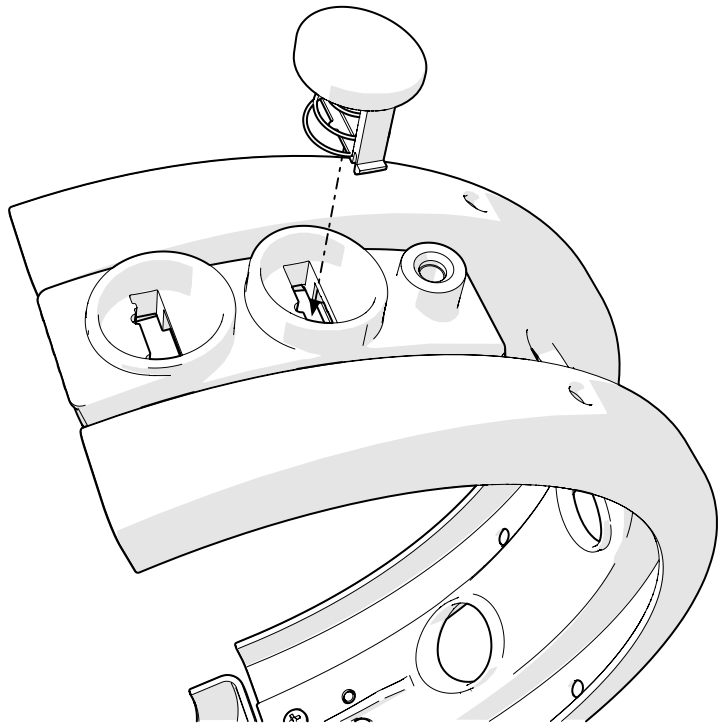
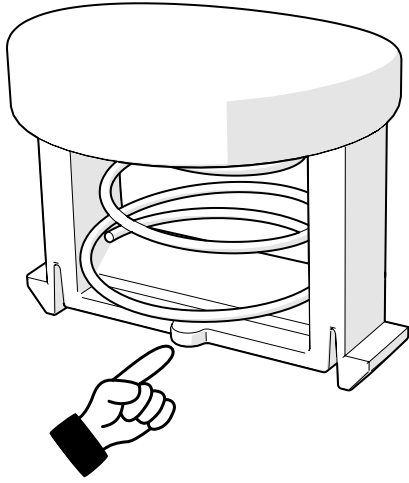

8

063.1013

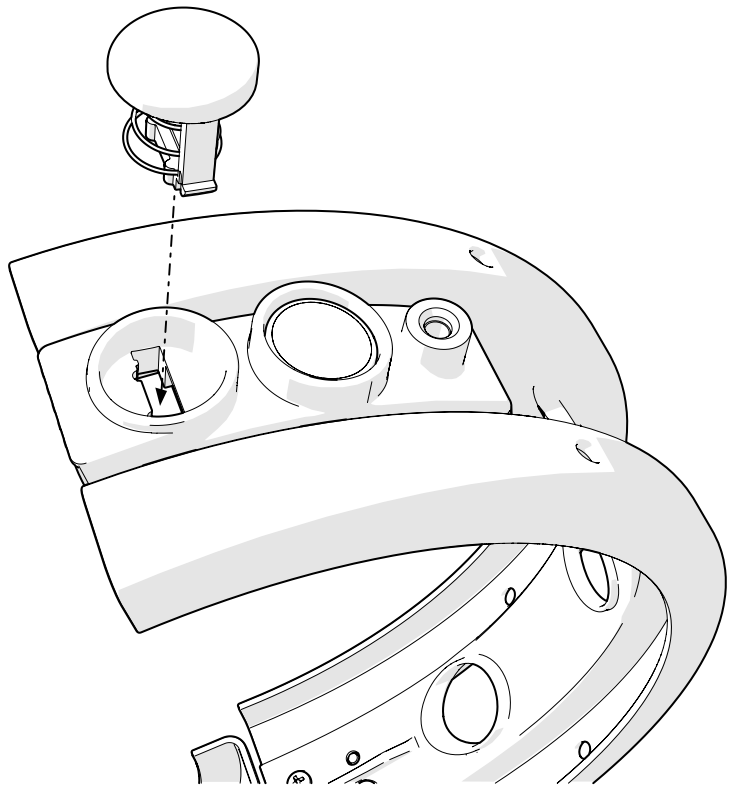
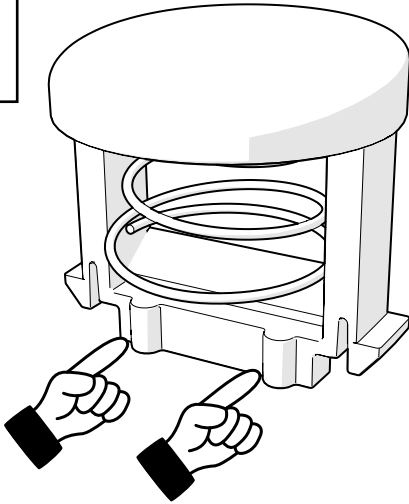

Omlet®



Please Reuse,
Compost,
Recycle.